

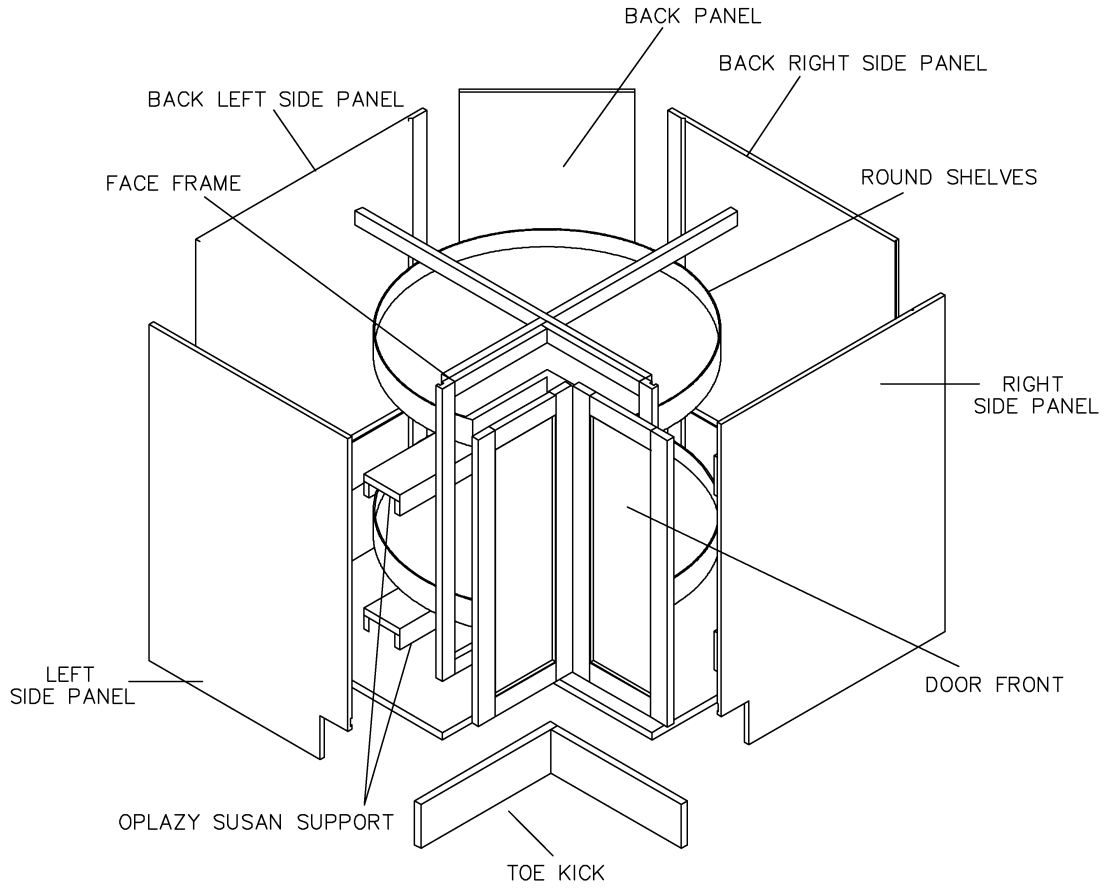

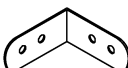

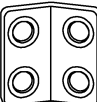



**ASSEMBLY INSTRUCTIONS - LAZY SUSAN CORNER CABINET**

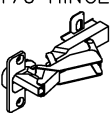

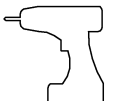
METAL BRACKETS 	METAL BRACKETS 	BIFOLD HINGE  ES/DS/SG	170 HINGE 	SCREWS 
---	---	---	--	---

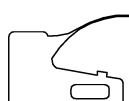
TOOLS				
 WOOD GLUE	 SCREW DRIVER	 RUBBER MALLET	 NAIL GUN	 STAPLER

This instruction applies to the following items:  
LZS33, LZS3612



STEP 1

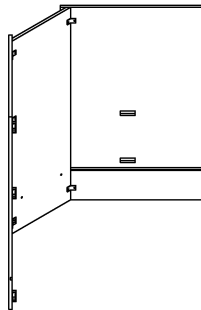

STEP 2

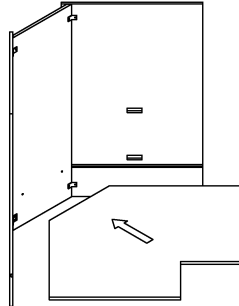

STEP 3

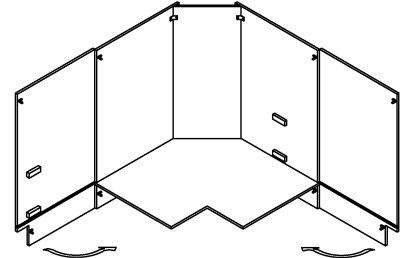

STEP 4

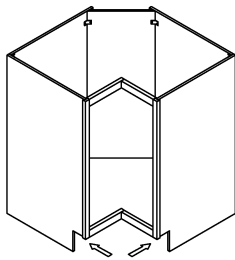

STEP 5

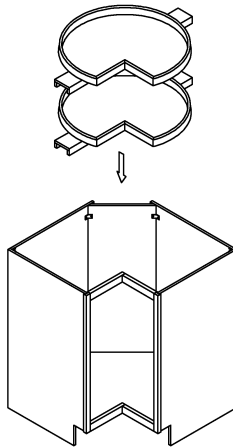

STEP 6

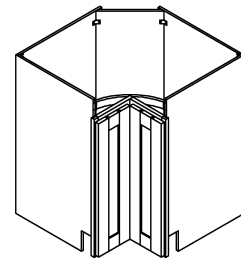

STEP 7

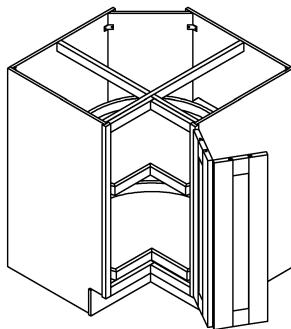

STEP 8

